

BLANCO

BLANCO FONTAS-S II Filter

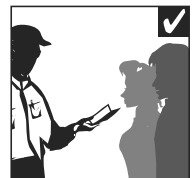

BLANCO FONTAS-S II Filter

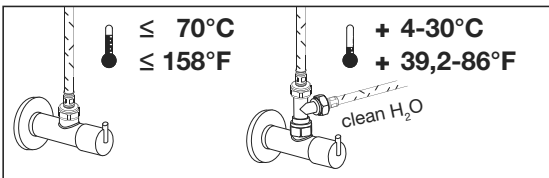
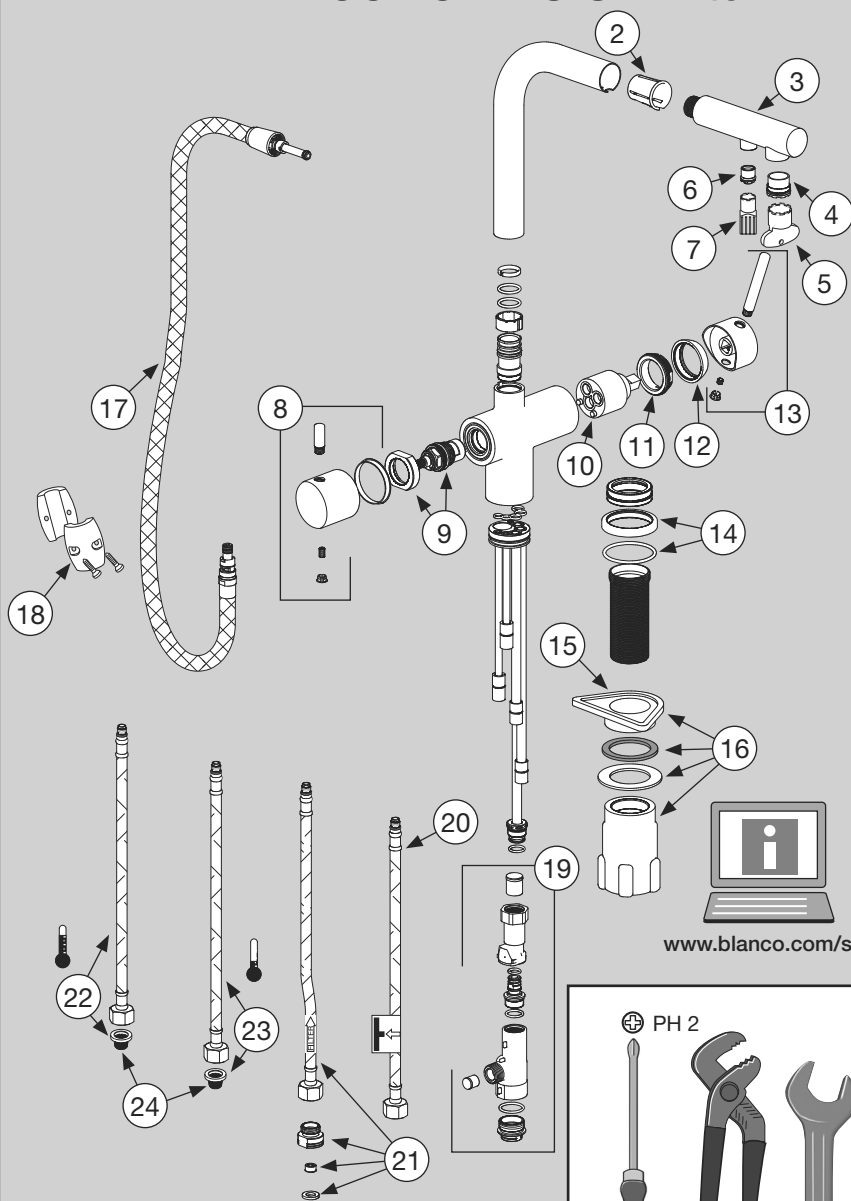

www.blanco.com/sos

PH 2

- 1x 14 mm
- 1x 19 mm
- 1x 22 mm

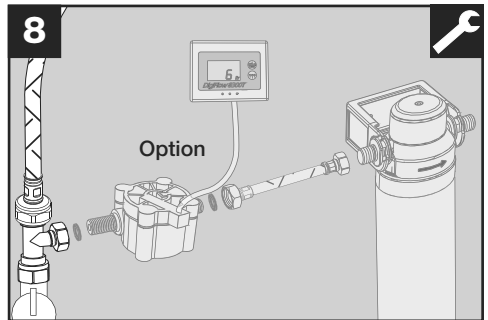
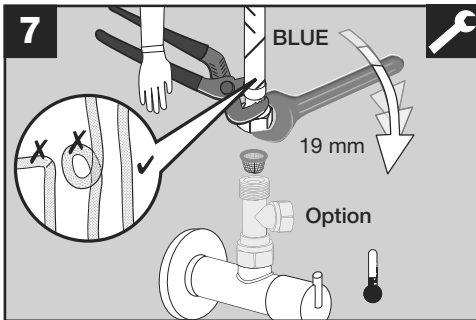
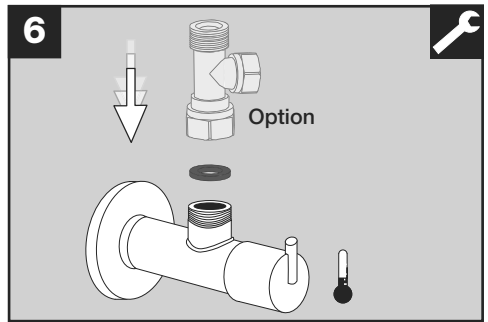
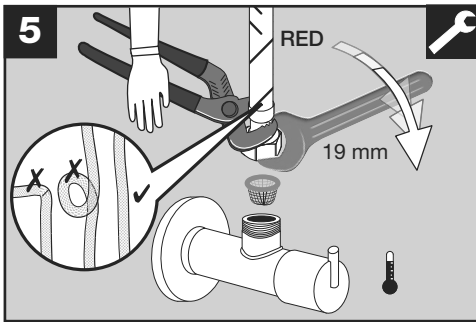
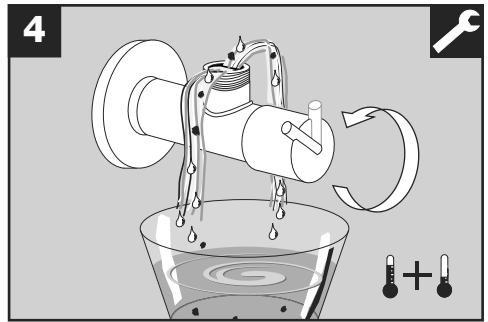
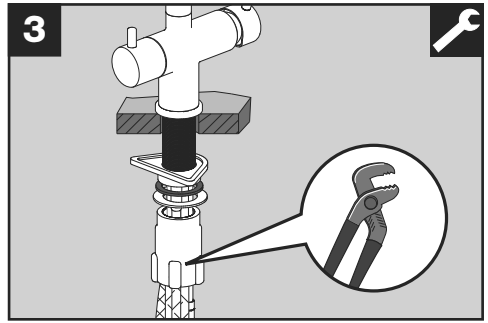
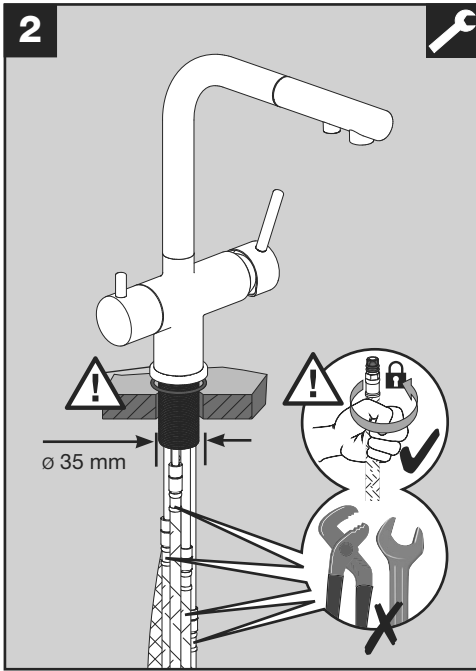

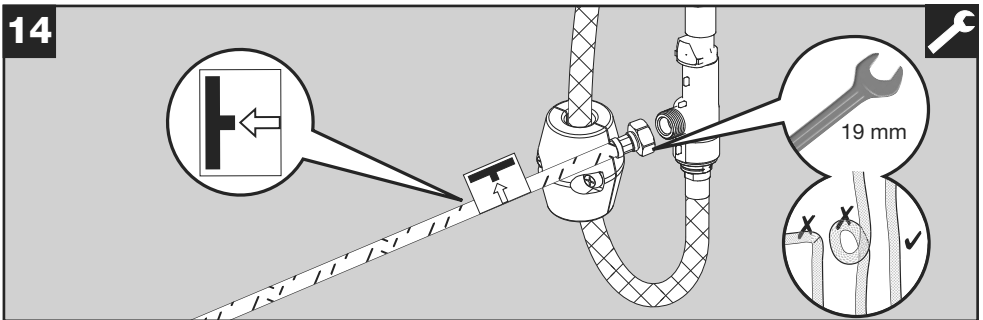
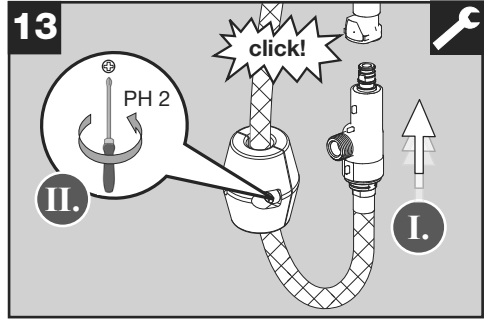
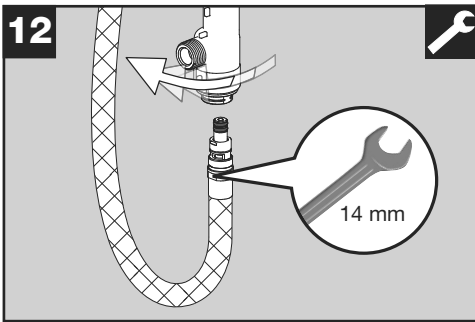
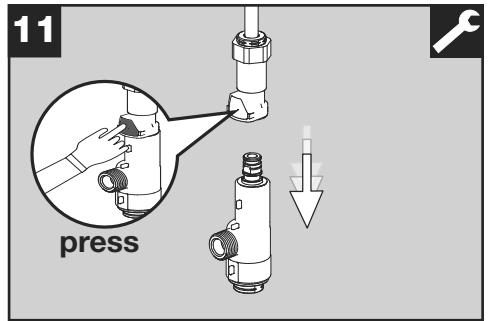
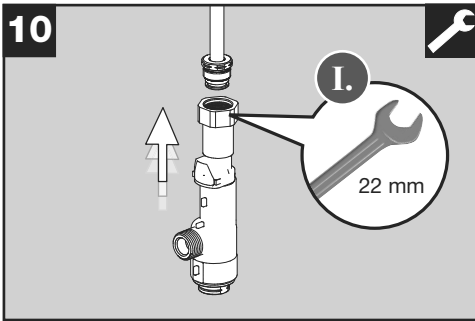
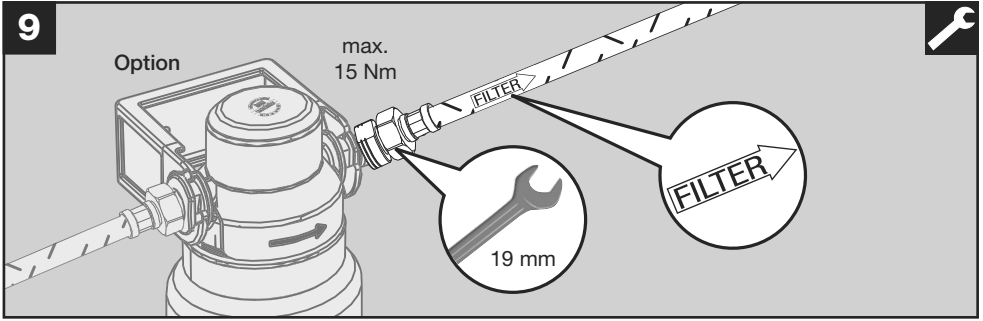

15

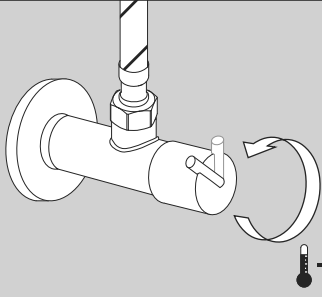

16

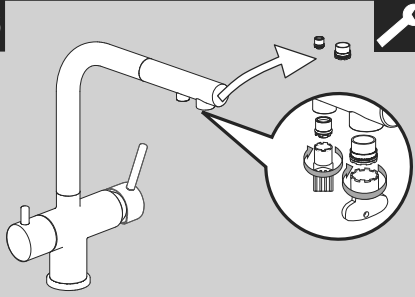

17

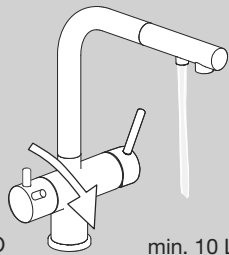

clean H₂O

min. 10 L



18

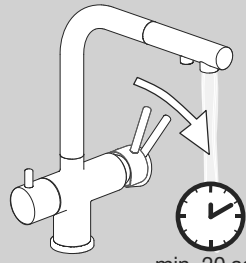

min. 20 sec.



19

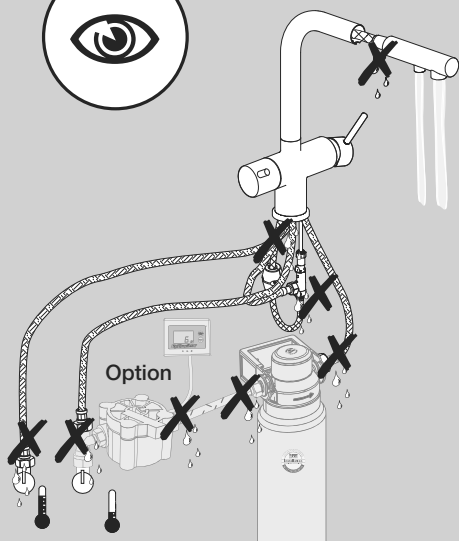

Option



20

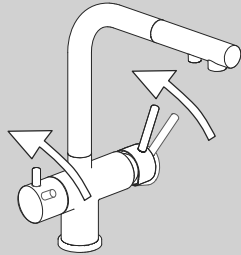

21

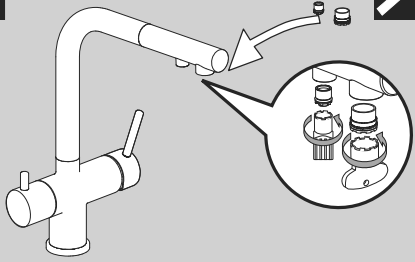

22

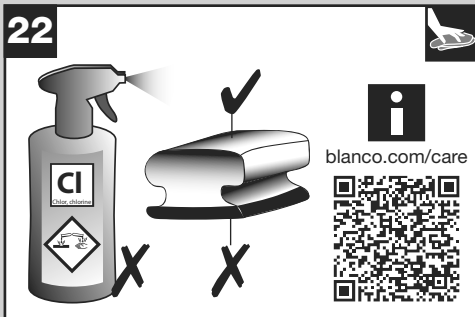

23

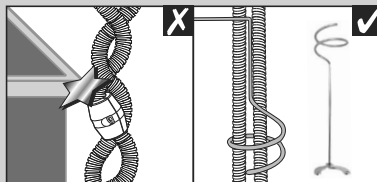
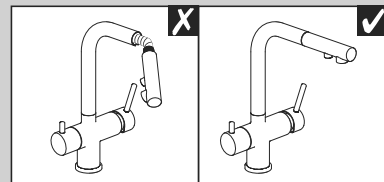
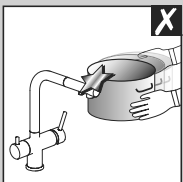
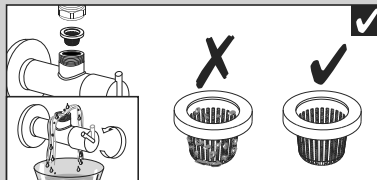
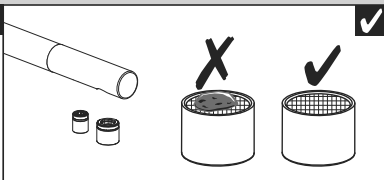
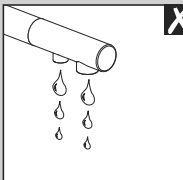
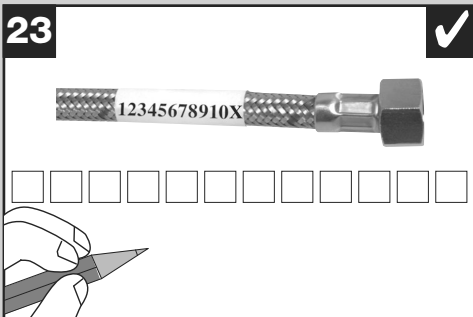

deu Um frisches gefiltertes Wasser für Getränke und Speisen zu zapfen, empfehlen wir, das Wasser, das länger - z.B. über Nacht - in der Leitung stand, ablaufen zu lassen. Das dauert je nach Strecke einige Sekunden: wenn das gefilterte Wasser kühler als das Stagnationswasser aus der Armatur kommt, ist es frisch.

eng To run fresh, filtered water for drinks and food, we recommend flushing out any water that has been sitting in the pipes for a long time, for instance overnight. This will take a few seconds depending on the length of the pipes – you will know the filtered water is fresh when it starts to run cooler.

spa Para extraer agua fresca filtrada para bebidas y alimentos, recomendamos que se deje salir el agua que haya estado durante en la tubería un tiempo prolongado, p. ej. durante la noche. Esto puede tardar unos segundos, dependiendo del recorrido: cuando el agua filtrada salga más fría que el agua estancada procedente de la grifería, significará que es agua fresca.

fra Pour tirer de l'eau fraîche filtrée pour les boissons et repas, nous vous recommandons de laisser couler l'eau si elle est restée longtemps – par exemple une nuit – dans la conduite. Selon la longueur de la conduite, ceci peut prendre quelques secondes : lorsque l'eau filtrée qui coule du robinet est plus froide que l'eau stagnante, il s'agit d'eau fraîche.

ned Om vers gefilterd water voor dranken en gerechten te tappen, adviseren wij om water, dat langere tijd – bv. gedurende de nacht – in de leiding heeft stilgestaan, eerst weg te laten lopen. Afhankelijk van de leidinglengte duurt dat enkele seconden: zodra het gefilterde water koeler uit de kraan komt dan het stilstaande water, is het vers.

zhx 为了汲取新鲜过滤的水来制作饮料和菜肴，我们建议您排空长时间积留在管道里的水（例如隔夜的水）。根据水流路径长短，这需要持续几秒钟：如果过滤水比水龙头里排出的积水更凉，说明过滤水是新鲜的。

BLANCO

 BLANCO GmbH + Co KG · Service · Tel.: +49 7045 44-81 419
 service@blanco.com · www.blanco.com

121 749 11/2022